

INDUSTRIAL DIESEL ENGINE

KUBOTA 05-SERIES (3-cylinder)

D1105-T-E3B



RATED POWER

24.5 kW/3000 rpm

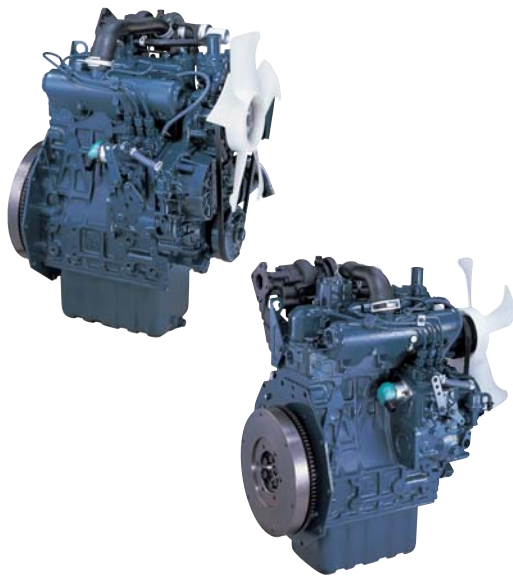

PERFORMANCE CURVE

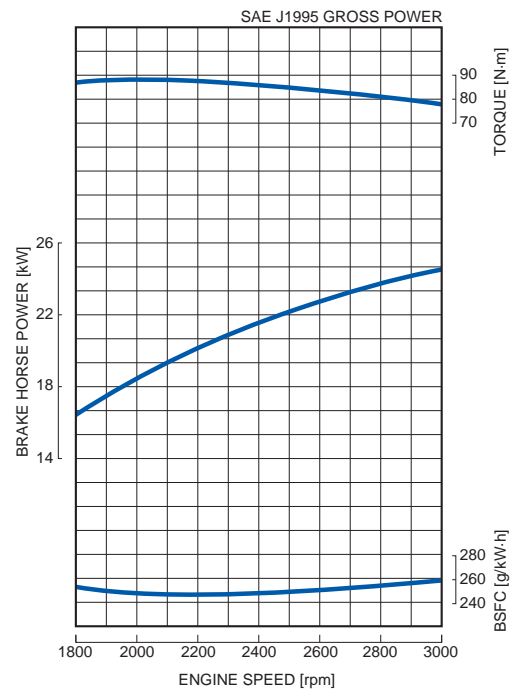

FEATURES with BENEFITS

Emissions

- The D1105 Turbocharged engine complies with EPA Interim Tier 4 emissions regulations that are effective through the end of 2012. This engine also complies with EU Stage 3A requirements that are effective through 2012 and beyond in the European market.

Durable Power

- The Kubota 05-Series is an established leader in its horsepower range and has been the preferred power source of various industrial equipment manufacturers.
- The D1105-T engine offers a seamless transition from Tier 2 to Interim Tier 4 by maintaining the same footprint and hardware mounting points with no performance changes from the Tier 2 engine.

Clean and Quiet Power

- The addition of a closed breather system meets EPA Interim Tier 4 requirements.
- Kubota's original E-TVCS (Three Vortex Combustion System) has been improved. The airflow, combustion chamber and piston recess were optimized to provide a 50% lower particulate matter (PM) level, the same stringent level as above the 37kW-class (EPA Interim Tier 4).

GENERAL SPECIFICATION

Model		D1105-T-E3B
Emission Regulation		Interim Tier 4 / Stage 3A
Type		Vertical 3-cycle Liquid Cooled Diesel
Number of Cylinders		3
Bore	mm (in)	78.0 (3.07)
Stroke	mm (in)	78.4 (3.09)
Displacement	L (cu.in)	1.123 (68.53)
Combustion System		Indirect Injection
Intake System		Turbocharged
Maximum Speed	rpm	3000
Output: SAE J1995 Gross Power	kW	24.5
	hp	32.8
	ps	33.3
Direction of Rotation		Counterclockwise Viewed on Flywheel
Oil Pan Capacity	L (gal)	5.1 (1.35)
Starter Capacity	V-kW	12-1.2 [US] / 12-1.4 [EU]
Alternator Capacity	V-A	12-40
Length	mm (in)	497.8 (19.60)
Width	mm (in)	433.0 (17.05)
Height (1)	mm (in)	626.0 (24.65)
Height (2)	mm (in)	227.6 (8.96)
Dry Weight	kg (lb)	97.0 (213.8)

*Specification is subject to change without notice.

*Dry weight is according to Kubota's standard specification.
When specification varies, the weight will vary accordingly.

*SAE J1995 Gross Power: 1-hour rating based on engine without cooling fan, air cleaner and muffler, with alternator.

DIMENSIONS

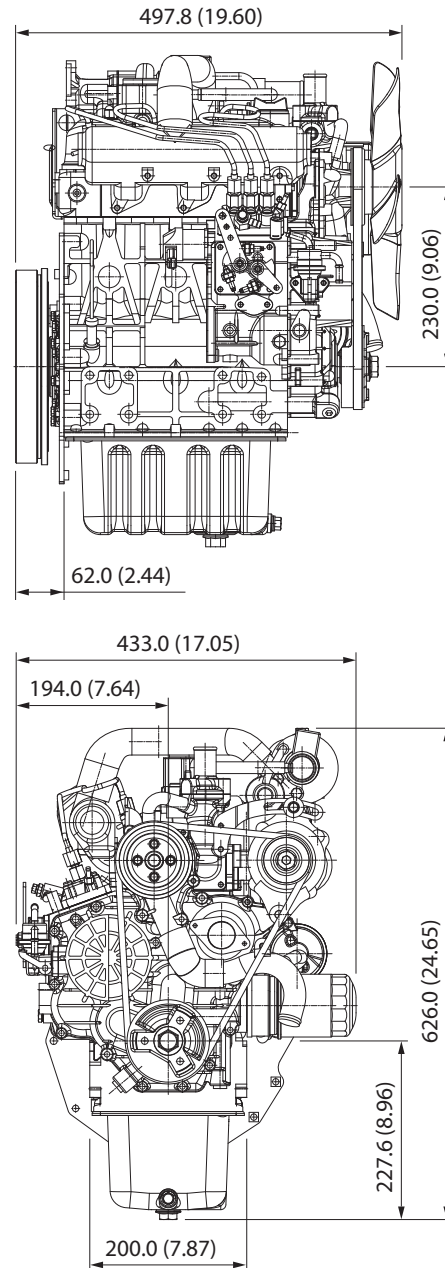

Kubota Corporation

2-47, Shikitsuhigashi 1-chome, Naniwa-ku, Osaka, 556-8601 Japan
 Fax: +81 (0) 6 6648 /35 21
<http://www.engine.kubota.ne.jp>

Kubota (Deutschland) GmbH

Senefelder Str. 3-5

63110 Rodgau

Phone: +49 (0) 6106 / 873 - 113

Fax: +49 (0) 6106 / 873 - 196

eMail: motoren@kubota.de

homepage: www.kubota.de